

SYSTEMATIC QUALITY

Main products



Catalogue



Technical lights

Pages 4 - 11

FlashLED 2
Rechargeable
battery-operated
luminaires



Page 4

TorchLED
Torch light



Pages 4-5

Torch light/
Headlamp



Page 5

Working lamps



Page 6

SpotLED 24
LED spotlight



Page 7

MultiLED 2
battery light



Page 7

Power distribution boxes

Pages 12-21

Power columns
ES 100/160



Page 12

Power column
QUADRO



Page 12

Small mobile
distributor boxes



Page 13

Mobile
wall-mounted
distributor boxes



Page 14

Mobile floor
distributor boxes



Page 14

Safety
transformers



Page 15

Cable Cable crossover

Pages 22-24

Cable



Page 22

Equipment
connection leads



Page 22

Extension cable



Page 23

Spiral cable



Page 23

Cable crossover

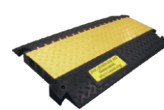

Page 24

Hose bridge



Page 24

Cable reels Spring-driven cable reels Plugs and sockets

Pages 25-28

Cable reels
plastic



Page 25

Cable reels
hard rubber

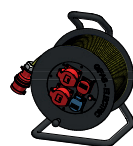

Pages 25-26

Spring-driven
cable reels type 520



Page 26

Spring-driven cable
reels type 521



Page 26

Hose reel
for air and water



Page 26

Plugs & Couplings
IP55



Page 27

Welding articles Welding accessories

Pages 29-31

Douflex
Welding cable



Page 29

Sets



Page 29

Ground clamps



Page 29

Earth terminal



Page 29

Welding
connections



Page 29

Electrode holder
with jaw



Page 29

PrimaLED 2
Working lamp



Page 7

AlphaLUXX
Spot light



Page 8

DeltaLUXX
Hall lighting fixtures



Page 9

Wide area lighting
system HPL



Page 9

ApolloLED 2N /
ApolloLED ECO



Page 10

StreamLED 2



Page 10

BetaLUXX



Page 10

FlexLED
+ Emergency
battery pack



Page 11

Mobile hard rubber
distributor boxes on
support



Page 15

Wall-mounted
distribution box
hard rubber



Page 16

Recessed-/surface
mounted distributors

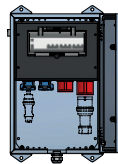

Page 17

Main distributor
boxes

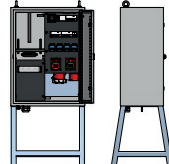

Pages 18-19

Applications



Pages 20-21

Plugs & Couplings
230V



Page 27

Plugs & Couplings
400V



Page 27

Personal safety
switches



Page 28

Diverse
plugs and sockets



Page 28

Electrode holder
with swivel head



Page 29

Further
products



Pages 30-31

FlashLED 2

work and inspection lamp with emergency light function



≥ 5h

IP65



Technical data

FlashLED 2

Operating voltage:	10 - 42VDC
Electric power supply:	Li-Ion-Akku 14.4V 2'600mAh
Charging time:	5h
Luminous period:	
– Spot (3 LED):	10h
– Wide (2 LED):	14h
– Full light (5 LED):	5h
– Emergency light (5 LED):	5h
Tube:	5 Power-LED à 3W, cool white 5'000K
Light output:	200lm - 1'250lm
Protection category:	IP65
Protection class:	III
Operating temperature range:	-20° to +45° C
Charging temperature range:	0° to +45° C
Dimensions (WxHxD)	
– Lamp excl. charging station:	252×123×93.4mm
– Lamp incl. charging station:	323×149×108mm
Weight:	approx. 1.1 kg

Charging station

Operating voltage:	230 VAC (85 - 264 VAC) or 12-24VDC
Protection category:	IP54
Protection class 230 VAC:	II
Protection class 12-24VDC:	III
Dimensions (WxHxD):	149×276×95mm
Weight:	430g

Item no.	Designation
✓ 861200	FlashLED 2 work and inspection lamp with emergency light function without charging station
✓ 860026	FlashLED charging station 230VAC (85-264 VAC), incl. 1.5 m cable and plug Euro
✓ 108125	FlashLED charging station FOCP 230 VAC (85 - 264 VAC), incl. 1.5 m cable and plug Euro
✓ 860027	FlashLED charging station 12 - 24VDC, with plug-in connection, without cable
✓ 860028	Charging cable with cigarette plug, L=2m
✓ 860029	Charging cable for permanent installation, with plug, L=2m

Accessories/spare parts

✓ 860030	Shoulder strap for FlashLED
✓ 212451	Coloured filter set for FlashLED (red, green, yellow)
✓ 861212	Spare battery 14.4V 2'600mAh for FlashLED 2
✓ 860744	Battery cover with magnetic strip to FlashLED 2

TorchLED torch light



IP54



Technical data

Power supply:	4 pcs AA 1.5V batteries or 4 pcs AA 1.5V accu cells
Protection category:	IP54
Light source:	LED
Equipment:	2×white, 2×red, 2×green
Housing:	– PA6-housing, with rubber overmolded handle lots (non-slip) – freestanding – belt clip (chrome steel) – mechanical resistant
Temperature range:	-20° C to +45° C
Dimension (W×H×D):	68×115.5×35mm
Weight:	approx. 115 g without accu cells

Item no.	Designation
✓ 860237*	TorchLED torch light yellow, IP54 incl. hand strap, excl. accu/battery
✓ 860240*	TorchLED torch light yellow, IP54, with magnet incl. hand strap, excl. accu/battery

Accessories/spare parts

✓ 860274	Accu-NiMH, 1.2V/1'900mAh HR6-AA
✓ 860275	Battery ALKALI, LR& AA 1.5V
✓ 128785	TorchLED wall holder empty, without accessories
✓ 860335	TorchLED belt pouch 12×127×35mm

*For a TorchLED art. 860274 or 860275 is 4×needed.



Rechargeable battery -and battery lamps

TorchLED torch light

with emergency light function or as Swiss Army



6h



IP54



Technical data

Power supply emergency light:	4 pcs AA 1.2V accu cells
Power supply Swiss army:	4 pcs. AA 1.5V batteries or 4 pcs. AA 1.2V accu cells
Protection category:	IP54
Light source:	LED
Equipment:	2×white, 2×red, 2×green
Housing:	– PA6-housing, with rubber overmolded handle lots (non-slip) – freestanding – belt clip (chrome steel) – mechanical resistant
Temperature range:	–20° C to +45° C
Dimension (W×H×D):	68×115.5×35mm
Weight:	approx. 115g without accu cells

In case of power failure, the light turns on automatically (broadlight 100%, lasting ~6h)

TorchLED Swiss Army

Item no.	Designation
✓ 860602*	TorchLED torch light army, yellow olive, IP54 incl. hand strap, excl. accu/battery

*For a TorchLED torch emergency light with battery, art. 860274 is 4×needed.

TorchLED with emergency light function

N° art.	Designation
✓ 860236*	TorchLED torch light emergency , red, incl. hand strap
✓ 860239*	TorchLED torch light emergency , red, incl. hand strap and with magnetic strip

*For a TorchLED torch emergency light with battery, art. 860274 is 4×needed.

Accessories/spare parts for TorchLED with emergency light function and TorchLED Swiss Army

N° art.	Designation
✓ 860276	TorchLED charging station 230VAC, 12-48VDC IP44, incl. 1.5m cable with plug-in transformer
✓ 860274	Accu-NiMH 1.2V/1900mAh HR6-AA
✓ 128785	TorchLED wall holder empty, without accessories

Torch light suprabeam®



Item no.	Designation
✓ 861241	Torch light LED Suprabeam Q1r 550lm incl. 1×Li-Po accu, USB-C cable
✓ 860754	Multifunction lamp LED Suprabeam M6xr, 2'000lm incl. 1×Li-Ion accu, USB adapter, headband, quick-release fastener, integrated magnetic base
✓ 861242	Torch light LED Suprabeam Q3r, 1'100lm, incl. 1×Li-Ion accu, USB-C cable
✓ 860703	Torch light LED Suprabeam Q3classic, 330lm incl. 3×AAA batteries and belt pouch
✓ 860752	Torch light LED Suprabeam, Q5xr, defend 1'000lm incl. 1×Li-Ion accu, USB connection

Accessories/spare parts

✓ 250023	Spare battery Li-Ion for Suprabeam Q3r
✓ 860790	Spare battery Li-Ion for Suprabeam M6xr
✓ 021811	Battery LR03 AAA/1.5V (apiece)
✓ 861243	Charger 4-fold (set with 4 batteries) for Suprabeam M6xr
✓ 861244	Signal cone orange for Q3xr
✓ 860708	Signal cone orange for Q5xr defend

Headlamp suprabeam®



Item no. 860947

Item no. 860707

Item no.	Designation
✓ 860947	Headlamp LED Suprabeam V3pro rechargeable 1'000lm, incl. 1×Li-Po accu, USB cable
✓ 860707	Headlamp LED Suprabeam S4 rechargeable, 750lm, incl. 1×Li-Po accu, USB cable

Accessories/spare parts

✓ 216788	Spare battery Li-Po for Suprabeam S4 rechargeable
✓ 860709	Spare accumulator Li-Po for Suprabeam V3pro rechargeable
✓ 216790	Helmet Clip for Suprabeam S4 rechargeable
✓ 217308	Helmet Clip-Set for Suprabeam S4 rechargeable
✓ 227473	Silicone headband black for Suprabeam V3pro rechargeable

Other versions, more accessories and spare parts on request.

✓ From stock, offer subject to prior sale

Working lamp suprabeam®



Art.-Nr. 860832



Art.-Nr. 860835



Art.-Nr. 860831



Art.-Nr. 860829



Art.-Nr. 860830

Item no.	Designation
✓ 860832	Working lamp Suprabeam W4r 4'400 lm, 1×Li-Ion accu, USB-C adapter
✓ 860831	Working lamp Suprabeam D4r 1'400 lm, 1×Li-Ion accu, USB-C adapter
✓ 860835	Working lamp Suprabeam W6r 4'600 lm, 1×Li-Ion accu, USB-C adapter
✓ 860829	Working lamp Suprabeam I2r 700 lm, 1×Li-Ion accu, USB-C adapter
✓ 860830	Working lamp Suprabeam I4r 1'000 lm, 1×Li-Ion accu, USB-C adapter

Accessories



Item no. 860833



Item no. 860836



Item no. 860834

Accessories / spare parts	
✓ 860833	Tripod Suprabeam for W4r /W6r height 0.73 - 1.65 m
✓ 860834	Magnet holder Suprabeam for W4r
✓ 860836	Spare battery Li-Ion 5.2Ah 14.8V for Suprabeam W6r

SpotLED FLEX Workplace light



Technical data

Operating voltage:	230 VAC
Power consumption:	115 mA
Connection cable:	1.8 m, 2×0.5 mm ² (PUR-cable)
Lamps:	5 PowerLED à 3 W
Light temperature:	6'000 K (cool white)
Beam Angles:	Spot / Medium
Protection category:	IP54 (without plug-in power pack)
Protection class:	III
Material housing:	made of die cast aluminum, black coated
Material flex hose:	steel, black coated
Material adapter:	steel, black coated
Surface temperature:	max. 55°C
Temperature range:	-30°C up to +45°C

Item no. Spot	Item no. Medium	length (X)	length (Z)	flex hose (Ø)
116285	116284	300 mm	–	14 mm
116287	✓ 116286	400 mm	–	14 mm
117613	117611	500 mm	200 mm	14 mm

Accessories / Spare parts	
✓ 110427	Plug-in power pack 230 VAC / 18 VDC, 1'200 mA incl. connection cable 1.8 m, black
✓ 024315	Magnetic clamp 540 N, Ø 86 mm, black for MULTI, spotlight, workplace light
✓ 104508	Protective glass (cover) polycarbonate
✓ 104431	Protective grid V2A
✓ 109212	Wing screw plastic, M5×10 mm

Other versions, more accessories and spare parts on request.

✓ From stock, offer subject to prior sale

LED spotlight / Battery light / PrimaLED 2

SpotLED 24 spotlight



IP67

SpotLED 24 spotlight

Small spotlight in modern design. Housing made of die cast aluminum, Bracket V2A-powder-coated, dimmable, vibration resistant.

Item no.	Designation
✓ 131064	SpotLED 24, cool white, 5×67°, 500 mA Housing Colour silver, with cable black 5 m, 3×0.25 mm ²
✓ 039636	SpotLED 24, cool white, 5×38°, 500 mA Housing Colour silver, with cable black 5 m, 3×0.25 mm ²
✓ 039643	SpotLED 24, cool white, 5×10°, 500 mA Housing Colour silver, with cable black 5 m, 3×0.25 mm ²

SpotLED 230 spotlight



Holderprotection

IP66

Spot Item no.	Medium Item no.	Wide Item no.	Comfort white 4'000K approx
✓ 860169	✓ 860170	✓ 860171	SpotLED 230V, 5m cable 3×1 mm ² , plug T12
Cool white 6'000K approx			
✓ 860172	✓ 860173	✓ 860174	SpotLED 230V, 5m cable 3×1 mm ² , plug T12

Accessories/Spare parts

✓ 110743	Pedestal complete incl. wingnuts, spacers, protective caps
----------	--

MultiLED 2 battery light with magnet holder



IP65

Item no.	Designation
✓ 840596	MultiLED 2 battery light 4.4mAh/7.4V/5×3W 6'500K, incl. charger 230VAC and car charger
✓ 189626	Charger 230V
840618	Charger 5-fold, 230V/70W for MultiLED 2

PrimaLED 2



IP05 **IP65** **IP55** **IK08**

Technical data

Operating voltage:	230VAC
System performance:	25.2W
Luminous flux:	4'200lm
Light efficiency:	165lm/W
Light temperature:	4'000K
Indice de rendu de couleurs:	Ra > 80
Operating life:	L70/B10 80'000h
Protection class:	I (230V with socket) II (230V without socket)
Protection category:	IP65 (without socket) IP54 (with socket)
Impact resistance:	IK08
Power supply:	mains connection
Temperature range:	-20°C to +40°C
Weight:	3.1 kg
Dimensions (W×H×D):	305×295×110mm

Item no.	Designation
✓ 228219	PrimaLED 2, 230V/25.2W, 4'200lm, incl. feed-in cable 5m, 3×1.0mm ² , T13, with built-in socket T13
✓ 228220	PrimaLED 2, 230V/25.2W, 4'200lm, incl. feed-in cable 10m, 3×1.0mm ² , T13, with built-in socket T13
✓ 228221	PrimaLED 2, 230V/25.2W, 4'200lm, incl. feed-in cable 5m, 2×1.0mm ² , T11, without built-in socket
✓ 228222	PrimaLED 2, 230V/25.2W, 4'200lm, incl. feed-in cable 10m, 2×1.0mm ² , T11, without built-in socket

Other versions, more accessories and spare parts on request.

✓ From stock, offer subject to prior sale

AlphaLUXX 25/40/60



5 YEARS
GUARANTEE



IP65



Technical data

Operating voltage:	100-277 VAC (50/60 Hz)
System performance:	25.4 W/40 W/60 W
Lighting current:	3'365 lm/5'152 lm/7'322 lm
LED power:	132 lm/W/128 lm/W/122 lm/W
Light colour:	4'000 K/5'000 K
Light source:	SMD-LEDs
Beam angles:	120°
CRI:	Ra >80
Operating life:	[L70/B10] > 80'000 h
Protection category:	IP65
Protection class:	I
Dimming:	optional DALI
Operating range of temperature:	
– AlphaLUXX 25:	–30° C to +60° C
– AlphaLUXX 40:	–30° C to +55° C
– AlphaLUXX 60:	–30° C to +50° C
Max. surface temperature:	+90° C (suitable for use in industrial premises with fire hazards), D rating label
Cover:	toughened safety glass 3 mm, (versions available transparent or frosted)
Weight:	approx. 2.7 kg
Measurements (L×W×H):	289×176×85.5 mm
Housing:	Die-cast aluminium
Housing surface:	PTFE-coated, suitable for the food industry
Housing colour:	black
Connection:	1 m connection cable, 3×1.5 mm ² H07RN
Certification:	ENEC, CE suitable for IFS (International Featured Standard)

Standard range «frosted glass»

	4'000 K*	5'000 K**	Designation
✓	860962	✓ 860961	AlphaLUXX 25, 230 VAC, 3'365 lm
✓	860960	✓ 860959	AlphaLUXX 40, 230 VAC, 5'152 lm
✓	860957	✓ 860956	AlphaLUXX 60, 230 VAC, 7'322 lm

* 4'000 K = 4'000 Kelvin, light colour comfort white

** 5'000 K = 5'000 Kelvin, light colour cool white

Other versions, more accessories and spare parts on request.

✓ From stock, offer subject to prior sale

AlphaLUXX 80/100/120

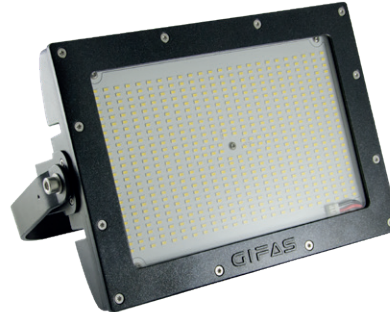

5 YEARS
GUARANTEE



IP65



Technical data

Operating voltage:	100-277 VAC (50/60 Hz)
System performance:	86 W/111 W/128 W
Lighting current clear glass:	12'801 lm/16'432 lm/18'636 lm
Lighting current frosted glass:	11'540 lm/14'052 lm/16'461 lm
LED power:	150 lm/W/148 lm/W/146 lm/W
Light colour:	4'000 K/5'000 K (3'000 K on request)
Light source:	SMD-LEDs
CRI:	Ra >80
Beam angles:	60°/90°/120°
Operating life:	> 80'000 h
Protection category:	IP65
Protection class:	I
Dimming:	optional DALI
Operating range of temperature:	
– AlphaLUXX 80:	–30° C to +60° C
– AlphaLUXX 100:	–30° C to +55° C
– AlphaLUXX 120:	–30° C to +50° C
Max. surface temperature:	+90° C (suitable for use in industrial premises with fire hazards), D rating label
Cover:	toughened glass, 5 mm optional PC, impact-resistant plastic cover, 5 mm (versions available transparent or satinised)
Weight:	approx. 7.0 kg
Measurements (L×W×H):	389×252×106.5 mm
Housing:	Die-cast aluminium
Housing surface:	PTFE-coated, suitable for the food industry
Housing colour:	black
Connection:	1 m connection cable, 3×1.5 mm ² H07RN
Certification:	ENEC, CE, suitable for IFS (International Featured Standard)

Standard range «clear glass»

	Clear glass		Frosted glass	Designation
	4'000 K*	5'000 K**	5'000 K**	
✓	860965	✓ 860964	✓ 860963	AlphaLUXX 80, 230 VAC
✓	860968	✓ 860967	✓ 860966	AlphaLUXX 100, 230 VAC
✓	860973	✓ 860972	✓ 860969	AlphaLUXX 120, 230 VAC

Other versions (e.g. 3'000 K, ball-impact resistant according to DIN VDE 0710-13), more accessories and spare parts on request.

Hall lighting fixtures / Wide area lighting system

DeltaLUXX



Technical data

Operating voltage:	100-277 VAC (50/60 Hz)
System performance:	95-270 W
Lighting current:	16'400-40'230 lm
Light colour:	5'000 K
Light source:	SMD-LEDs
CRI:	Ra > 80
Beam angles:	~30° / ~60° / ~120°
LED-Operating life:	[L70/B10] > 80'000 h
Protection category:	IP65
Protection class:	I
Dimming:	optional DALI
Operating range of temperature	
- 90-170:	-30° C to +60° C
- 200:	-30° C to +55° C
- 240-250:	-30° C to +50° C
Max. surface temperature:	+90° C (suitable for use in industrial premises with fire hazards), D rating label
Cover:	3 mm toughened glass (Vision) or 3 mm polycarbonate
Weight:	approx. 9.5 kg
Measurements(Ø×H):	450×195 mm
Housing:	Die-cast aluminium
Housing surface:	PTFE-coated
Housing colour:	black
Certification:	ENEC, CB, CE, D rating label

Other versions on request (e.g. 3'000 K, 4'000 K).

~30° Beam angle	
800161	DeltaLUXX 150, 230 VAC, 5'000 K, 17'089 lm
800163	DeltaLUXX 240, 230 VAC, 5'000 K, 24'418 lm
~60° Beam angle	
✓ 800406	DeltaLUXX 2 130, 230 VAC, 5'000 K, 21'400 lm
800409	DeltaLUXX 2 250, 230 VAC, 5'000 K, 40'230 lm
~120° Beam angle	
✓ 800290	DeltaLUXX 2 130, 230 VAC, 5'000 K, 22'400 lm
✓ 800839	DeltaLUXX 2 170, 230 VAC, 5'000 K, 28'100 lm, DALI
✓ 800294	DeltaLUXX 2 200, 230 VAC, 5'000 K, 32'400 lm
✓ 800296	DeltaLUXX 2 250, 230 VAC, 5'000 K, 38'900 lm

Wide area lighting system HPL



Technical Data

Operating voltage:	100-240 VAC
LED power / System performance:	
- 450 W:	460 W
- 900 W:	920 W
- 1'350 W:	1'380 W
LED efficiency:	146 lm/W
Incide of CRI:	Ra > 70
Operating life:	L80/B50 > 97'000 h
LED switching capability:	> 1 mil
Protection category:	IP66
Impact resistance:	IK10
Protection class:	I
MacAdam:	3-step
Dimmable:	Yes
Operating range of temperature:	-20° C to +50° C
Integrated thermal management:	Yes
Max. surface temperature:	+90° C (suitable for use in industrial premises with fire hazards), D rating label
Weight:	
- 450 W:	19.2 kg
- 900 W:	33.3 kg
- 1'350 W:	42.8 kg
Dimensions l×h×w:	
- 450 W:	390×685×240 mm
- 900 W:	700×685×240 mm
- 1'350 W:	700×890×240 mm
Material housing:	Aluminium
Housing colour:	black
Swivel angle of bracket:	270°

*h = with bracket folded downwards

Item no.	Designation
✓ 861033	Wide area lighting system HPL 450 W, 230 VAC, 110°, 5'700 K, 57'000 lm, IP66, DALI
✓ 861034	Wide area lighting system HPL 450 W, 230 VAC, asym. 130°×60° , 5'700 K, 68'600 lm, IP66, DALI
✓ 861002	Wide area lighting system HPL 900 W, 230 VAC, asym. 130°×40° , 5'700 K, 134'000 lm, IP66, DALI
✓ 861004	Wide area lighting system HPL 1'350 W, 230 VAC, asym. 130°×40° , 5'700 K, 197'600 lm, IP66, DALI

60° version available on request

✓ From stock, offer subject to prior sale

ApolloLED 2N

Technical data

Input voltage:	100-277 VAC
Power consumption:	
– 50% illuminated:	220 W
– 100% illuminated:	440 W
Lighting current:	53'760 lm
LED power:	122 lm/W
Light colours:	5'000 K
Operating life:	>50'000 h
Protection category:	IP44
Protection class:	I
Operating range of temperature:	-25°C to +45°C
Measurements LxD:	900x208 mm
Weight:	11 kg
Utilisation height:	3.5 m
Illumination area:	>700 m ²



IP44

Item no.	Designation
✓ 246988	ApolloLED 2N, 230 V/896x0.5 W, incl. power supply 5 m 3x1.5 mm ² , T13, incl. transport case
✓ 800211	ApolloLED 2N, 230 V/896x0.5 W, excl. power supply and transport case
✓ 102009	Tripod, steel chromatised, h=max. 3.7 m, with crank winch, max load 30 kg, tube ø38 mm

ApolloLED ECO

Technical data

Input voltage:	100-277 VAC
System performance:	307.5 W
Lighting current:	32'321 lm
LED power:	110 lm/W
	incl. fan
Light colours:	5'000 K
Operating life:	>50'000 h
Protection category:	IP44
Protection class:	I
Operating range of temperature:	-25°C to +50°C
Measurements LxD:	600x208 mm
Weight:	7.5 kg
Utilisation height:	2.7 m
Illumination area:	>600 m ²



IP44

Item no.	Designation
✓ 184857	ApolloLED ECO, 230 V, 300 W, 32'321 lm, incl. feed-in cable 5 m 3x1.5 mm ² , plug T13, incl. transport bag
✓ 184858	Tripod, steel /aluminum powder-coated, h=max. 2.4 m, with crank winch, max load 50 kg, tube ø35 mm

StreamLED 2 – pluggable



IK08 IP66

Item no. PMMA Acrylglas	Output	Luminous flux	Light colour	Length mm
✓ 860660	20 W	2'121 lm	4'000 K	786
✓ 860661	20 W	2'121 lm	5'000 K	786
✓ 860662	35 W	4'245 lm	4'000 K	1'265
✓ 860663	35 W	4'245 lm	5'000 K	1'265
✓ 860664	55 W	7'102 lm	4'000 K	1'744
✓ 860665	55 W	7'102 lm	5'000 K	1'744

StreamLED 2 – direct connection



IK10 IP66/IP69

Item no. PMMA Acrylglas	Output	Luminous flux	Light colour	Length mm
✓ 860666	20 W	2'121 lm	4'000 K	751
✓ 860667	20 W	2'121 lm	5'000 K	751
✓ 860668	35 W	4'245 lm	4'000 K	1'230
✓ 860669	35 W	4'245 lm	5'000 K	1'230
✓ 860670	55 W	7'102 lm	4'000 K	1'709
✓ 860671	55 W	7'102 lm	5'000 K	1'709

BetaLUXX

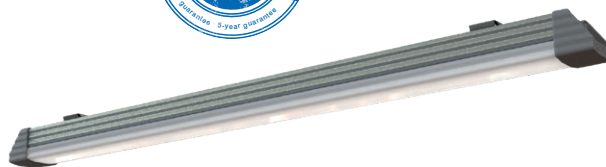

5 YEARS GUARANTEE



IP66

IK10



BetaLUXX complete with plug and connector

3'000 K	4'000 K	5'000 K	
✓ 860627	✓ 860626	✓ 860616	BetaLUXX 20, 230 VAC, 1'964 lm
✓ 860628	✓ 860614	✓ 860470	BetaLUXX 40, 230 VAC, 3'929 lm
✓ 860629	✓ 860615	✓ 860480	BetaLUXX 60, 230 VAC, 6'574 lm

Other versions, more accessories and spare parts on request.

✓ From stock, offer subject to prior sale

FlexLED – LED light strip on cable reel or reel



Handle with integrated elastic band to lock the cable reel

Technical Data

LED:	LED strip double-sided (2×180 LEDs/m)
System performance:	13W/m
Light efficiency:	1'500lm/m
Light colours:	white 3'000K/4'000K, red, green, blue
Beam angles:	240° (120° per side)
Operating life:	> 30'000h
Protection category:	IP65
Impact resistance:	IK10
Operating temperature range:	-25°C to +55°C
Weight reel with	
– 5m:	approx. 1.2kg
– 10m:	approx. 2.3kg
Weight cable reel with 25m:	approx. 6.2kg
Dimensions light strip (L×W):	16×8mm
Length:	5m/10m/25m (extendable to max. 100m)
Connection cable:	1.5m 2×1.5mm ² rubber cable with CH-plug IP55 type 11



Handle with integrated elastic band to lock the cable reel

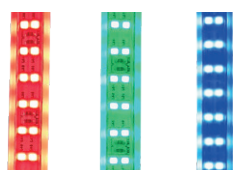

Light colour variants

FlexLED – Emergency battery pack (optional)



Technical Data

Output:	50W
Emergency operation rechargeable battery:	120min
Battery level:	Display via indicator light
Connected power:	max. 1'500W
Input voltage:	100-277V AC
Output voltage:	175DC
Battery:	22.2V 6'000mAh Li-Ion battery
Charging time:	> 8h (80%)
Emergency trigger time:	<1 s
Protection category:	IP65
Impact resistance:	IK08
Temperature range:	-10°C to +45°C
Connection cable:	1.5m 3×1.5mm ² rubber cable with plug and connector IP55 type 13

Emergency operation brightness:

10m:	30%	450lm/m
25m:	20%	300lm/m
50m:	10%	150lm/m

Battery status query:

With the emergency function switched on, briefly press the illuminated pushbutton to indicate the power supply.

Number of red light flashes (flashing):	
1× =	0% – 20% remaining power
2× =	20% – 40% remaining power
3× =	40% – 60% remaining power
4× =	60% – 80% remaining power
5× =	80% – 100% remaining power

Item no.	Designation
✓ 861055	FlexLED on a reel 10m, 3'000K, Wide 240°
✓ 861054	FlexLED on a reel 10m, 4'000K, Wide 240°
✓ 861049	FlexLED on cable reel 25m, 3'000K, Wide 240°
✓ 861022	FlexLED on cable reel 25m, 4'000K, Wide 240°
✓ 861235	FlexLED on reel 5m, red, Wide 240°
✓ 861236	FlexLED on reel 5m, green, Wide 240°
✓ 861237	FlexLED on reel 5m, blue, Wide 240°
✓ 861086	Connection cable CH-plug type 11
✓ 251254	Extension cable 5m 2×1.5mm ²
✓ 251253	T-connector

Item no.	Designation
✓ 861052	FlexLED emergency battery pack

✓ From stock, offer subject to prior sale

Power columns ES 100/160

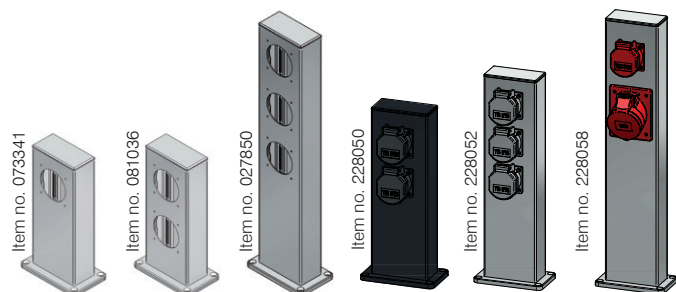

Technical Data

Material: The energy column will be delivered without fixing material made (on site)

Protection category:

- IP20: No protection against moisture
- IP44: Splashproof
- IP55: (at appropriate built-ins)

Aluminium column type ES 100

Item no.	Designation	Height	Equipment
✓ 073341	Aluminium column, anodised aluminium	250 mm	1 bore Ø60 mm
✓ 081036	Aluminium column, anodised aluminium	250 mm	2 bores Ø60 mm
✓ 027850	Aluminium column, anodised aluminium	400 mm	drilling 3×NUP
✓ 228050	Aluminium column, black painted, RAL9005	300 mm	2×T13
✓ 228052	Aluminium column, anodised aluminium	390 mm	3×T13
✓ 228058	Aluminium column, anodised aluminium	500 mm	1×T25, 1×CEE 16/5



Aluminium column type ES 160

Item no.	Designation	Height	Equipment
228060	Aluminium column, anodised aluminium	800 mm	1×T23, 1×T25, 1×CEE 16/5, 2×CEE 32/5

QUADRO



The QUADRO can be used for many outdoor applications and optically fits perfectly into the environment. The QUADRO has perfect vandal-proof design, and thanks to the compact internal rubber distributor the column is also ideally suited to very rough environments.

Thanks to the flexible cable outlet flap, outside influences can also be reduced to a minimum during operation.

Two locks are standard equipment for the QUADRO (1×KABA 5000/ 1×4-way 8mm).

The QUADRO can be selected and ordered as modules:

- three possible cover versions
- various power distribution options (various equipment options)
- individual lock versions

Item no.	Designation	Locks	Equipment
228937	QUADRO without lighting	KABA 5000/ 4-way	KSV 7400 2×T23 2×T25 1×CEE 16/5 1×CEE 32/5
228941	QUADRO with diffuse lighting	KABA 5000/ 4-way	KSV 7400 2×T23 2×T25 1×CEE 16/5 1×CEE 32/5
228942	QUADRO with LED lighting	KABA 5000/ 4-way	KSV 7400 2×T23 2×T25 1×CEE 16/5 1×CEE 32/5

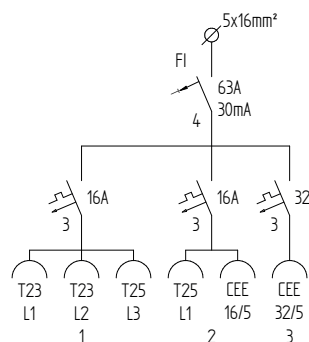

Other versions, more accessories and spare parts on request.

✓ From stock, offer subject to prior sale

Small mobile distributor boxes, hard rubber

Hard rubber distributor boxes type 1400



Specification

- solid rubber enclosure type 1400
- mounted with 1 strap V2A
- with flap made out of Plexiglas
- colour black
- protection category IP55
- L×W×H=78×290×65 mm

Item no.	Designation	Equipment
✓ 229362	Hard rubber distributor box type 1400	2 built-in sockets T13/10A/230V 1 switch FI 1N-25A/30mA 1 cable gland M20 Input: 5m cable Gifaflex 3×1.5mm ² , yellow, with plug T13

Hard rubber distributor boxes type 1400



Specification

- solid rubber enclosure type 1400
- mounted with cable reel behind
- colour black
- protection category IP55
- L×W×H=290×78×65 mm

Item no.	Designation	Equipment
✓ 229366	Hard rubber distributor box type 1400	4 built-in sockets T13/10A/230V 1 protective rubber sleeve Input: 5m cable Gifaflex 3×1.5mm ² , yellow, with plug T13

Hard rubber distributor box type 1400

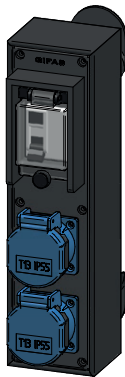

Specification

- solid rubber enclosure type 1400
- mounted with cable reel behind
- colour black
- protection category IP55
- L×W×H=78×290×65 mm

Item no.	Designation	Equipment
✓ 229361	Hard rubber distributor box type 1400	2 built-in sockets T13/10A/230V 1 switch FI, 1N-25A/30mA 1 protective rubber sleeve Input: 5m cable Gifaflex 3×1.5mm ² , yellow, with plug T13

Small mobile distributor box, hard rubber type 1812

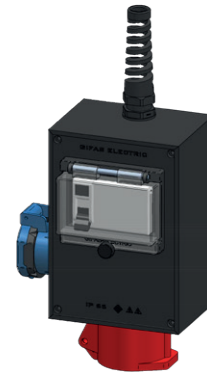

Specification

- solid rubber enclosure type 1812
- with flap made out of Plexiglas
- colour black
- protection category IP44
- L×W×H=125×180×90 mm

Item no.	Designation	Equipment
✓ 229450	Small mobile distributor box hard rubber type 1812	1 built-in socket T23/16A/230V 1 built-in socket type CEE16/5/400V 1 switch FI 3N-40A/30mA 1 cable gland M20 Input: 3m cable Gifaflex 5×1.5mm ² , yellow, with plug CEE16/5

Other versions, more accessories and spare parts on request.

✓ From stock, offer subject to prior sale

Mobile wall-mounted distributor box, hard rubber type 7300

Specification

- solid rubber enclosure type 7300
- with protective collar and flap, handle and mounting bracket
- colour black
- protection category IP44
- L×W×H = 200×350×133mm



Item no.	Designation	Equipment
✓ 229657	Mobile wall-mounted distributor box, hard rubber type 7300	2 built-in sockets T23/16A/230V 1 built-in socket T25/16A/230/400V 2 built-in sockets CEE 16/5/400V 1 switch FI 3N-40A/30mA 1 circuit breaker 1-16A «C» 1 circuit breaker 3-16A «C» 1 clamp web 5×16mm ² 2 cable glands M25 without cable

Mobile floor distributor box, hard rubber type 6200

Specification

- solid rubber enclosure type 6200
- with handle
- colour black
- protection category IP44
- L×W×H = 280×275×230mm

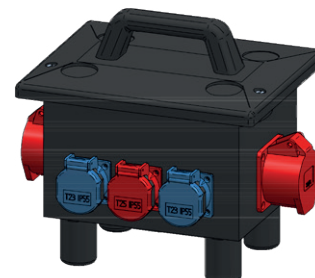

Item no.	Designation	Equipment
✓ 229457	Mobile floor distributor box, hard rubber type 6200	2 built-in sockets T23/16A/230V 1 built-in socket T25/16A/230/400V 2 built-in sockets CEE 16/5/400V 1 switch FI 3N-40A/30mA 1 cable gland M20 Input: 5 m cable Gifaflex 5×2.5mm ² , yellow, with plug CEE 16/5

Mobile wall-mounted distributor box, hard rubber type 7400

Specification

- solid rubber enclosure type 7400
- with protective collar and flap, handle and mounting bracket
- colour black
- protection category IP44
- L×W×H = 266×370×133mm

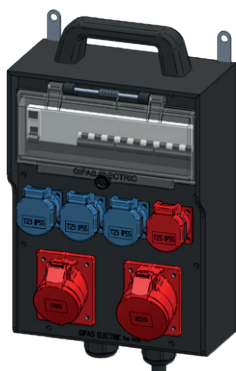

Item no.	Designation	Equipment
✓ 229661	Mobilier wall-mounted distributor box, hard rubber type 7400	3 built-in sockets T23/16A/230V 1 built-in socket T25/16A/230/400V 1 built-in socket CEE 16/5/400V 1 built-in socket CEE 32/5/400V 1 switch FI 3N-40A/30mA 2 circuit breaker 3-16A «C» 1 circuit breaker 3-32A «C» 1 clamp web 5×16mm ² 2 cable gland M32 without cable

Mobile floor distributor box, hard rubber type 6700

Specification

- solid rubber enclosure type 6700
- with handle
- colour black
- protection category IP44
- L×W×H = 350×253×280mm

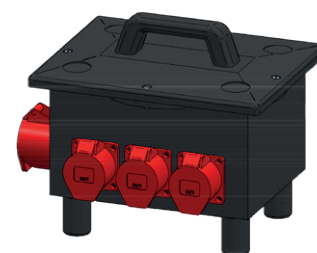

Item no.	Designation	Equipment
✓ 229461	Mobile floor distributor box, hard rubber type 6700	2 built-in sockets T23/16A/230V 2 built-in sockets T25/16A/230/400V 3 built-in sockets CEE 16/5/400V 1 built-in socket CEE 32/5/400V 1 switch FI 3N-40A/30mA 1 circuit breaker 1-16A «C» 2 circuit breaker 3-16A «C» 1 cable gland M25 Input: 3 m cable Gifaflex 5×4.0mm ² , yellow, with plug CEE 32/5

Other versions, more accessories and spare parts on request.

✓ From stock, offer subject to prior sale

Mobile safety transformer 230/24V/120VA type 2516

Specification

- solid rubber enclosure type 2516
- with handle
- colour black
- protection category IP44
- L×W×H = 250×215×90 mm
- power: 120VA
- input 3 m 2×1.5 mm² with plug T13
- installations: 1 thermal overcurrent protection switch
- primary protection: 0.6A

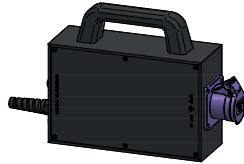

Item no.	Designation
229712	Safety transformer 120VA type 2516 230/24V – 1×CEE 2×16A/24V, 3 m 2×1.5, T13

Mobile hard rubber distributor box mounted on foldable stand

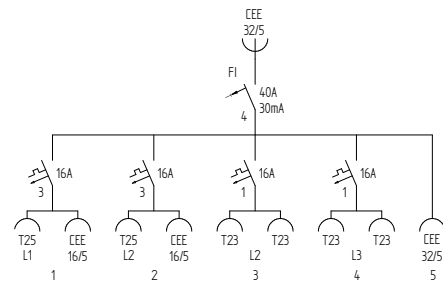
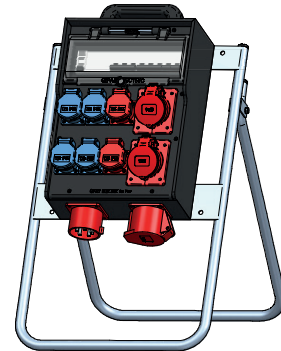

Item no.	Designation
✓ 228745	Mobile hard rubber distributor boxes type 7400 connector plug CEE 32/5 on foldable stand V2A

Mobile safety transformer 230/24V/320VA, 500VA, type 6200

Specification

- solid rubber enclosure type 6200
- with handle
- colour black
- protection category IP44
- L×W×H = 280×275×230 mm
- power: 2×CEE 2×16A/24V
- pnpot 3 m 2×1.5 mm² with plug T13
- installations: 1 thermal overcurrent protection switch

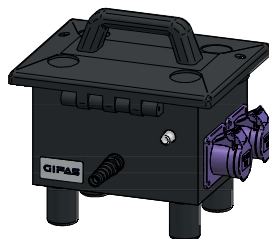

Item no.	Designation
229713	Safety transformer 320VA type 6200 230/24V – 2×CEE 2×16A/24V, 3 m 2×1.5, T13
229714	Safety transformer 500VA type 6200 230/24V – 2×CEE 2×16A/24V, 3 m 2×1.5, T13

Other versions, more accessories and spare parts on request.

✓ From stock, offer subject to prior sale

Small mobile distributor box hard rubber type 2516/wall-mounted distributor box hard rubber type 7400

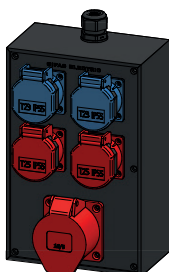

Item no. 228739

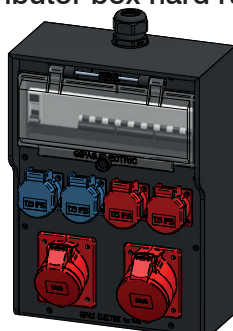

Item no. 228403

Item no.	Designation	Equipment
✓ 228739	Hard rubber distributor box type 2516 L×W×H = 160×250×90mm Pre-fuse max. 16A	2×T23, 2×T25 1×CEE 5×16A/400V Input: 1×M20 above
✓ 228403	Hard rubber distributor box type 7400 L×W×H = 266×370×133mm Pre-fuse max. 63A	2×T23 2×T25 1×CEE 5×16A/400V 1×CEE 5×32A/400V Input: 1×M32 above

Wall-mounted distributor boxes hard rubber type 7300

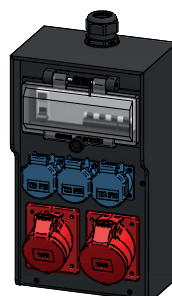

Item no. 228780

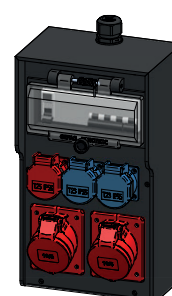

Item no. 228778

Item no.	Designation	Equipment
✓ 228780	Hard rubber distributor box type 7300 L×W×H = 200×350×133mm Pre-fuse max. 32A	3×T23 1×CEE 5×16A/400V 1×CEE 5×32A/400V Input: 1×M32 above
✓ 228781	according to 228780	According to 228780 Input: 1×M32 below
✓ 228778	Hard rubber distributor box type 7300 L×W×H = 200×350×133mm Pre-fuse max. 63A	2×T23, 1×T25 2×CEE 5×16A/400V Input: 1×M25 above
✓ 228779	according to 228778	According to 228778 Input: 1×M25 below

Wall-mounted distributor boxes hard rubber type 7400

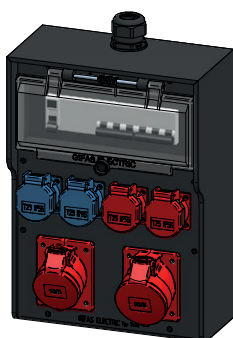

Item no. 228402

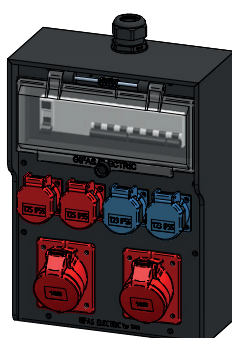

Item no. 228345

Item no.	Designation	Equipment
✓ 228402	Hard rubber distributor box type 7400 L×W×H = 266×370×133mm Pre-fuse max. 32A	2×T23 2×T25 1×CEE 5×16A/400V 1×CEE 5×32A/400V Input: 1×M32 above
✓ 228350	according to 228402	dito 228402 Input: 1×M32 below
✓ 228345	Hard rubber distributor box type 7400 L×W×H = 266×370×133mm Pre-fuse max. 40A	2×T23 2×T25 2×CEE 5×16A/400V Input: 1×M32 oben
✓ 228346	according to 228345	dito 228345 Input: 1×M32 below

Wall-mounted distributor boxes hard rubber type 7700

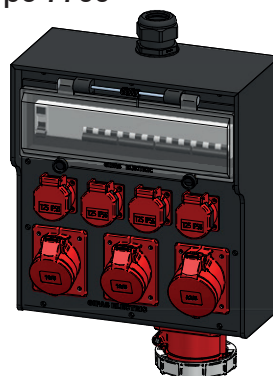

Item no. 228406

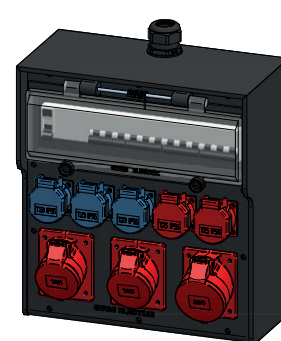

Item no. 228794

Item no.	Designation	Equipment
✓ 228406	Hard rubber distributor box type 7700 L×W×H = 336×370×162mm Pre-fuse max. 63A	4×T25 2×CEE 5×16A/400V 1×CEE 5×32A/400V 1×CEE 5×63A/400V Input: 1×M40 above
✓ 228674	according to 228406	according to 228406 Input: 1×M40 below
✓ 228794	Hard rubber distributor box type 7700 L×W×H = 336×370×162mm Pre-fuse max. 80A	3×T23 2×T25 2×CEE 5×16A/400V 1×CEE 5×32A/400V Input: 1×M32 above
✓ 228795	according to 228794	according to 228794 Input: 1×M32 below

Other versions, more accessories and spare parts on request.

✓ From stock, offer subject to prior sale

Surface mounted and recessed mounted power distribution boxes

Thanks to GIFAS recessed-/surface mounted distributor cabinets you have access to a product range which is fulfilling highest demands. GIFAS attaches great importance on robust and stable design!

In addition to our standard range we can also provide individual, customized solutions.

Surface mounted power distribution box type 63 A

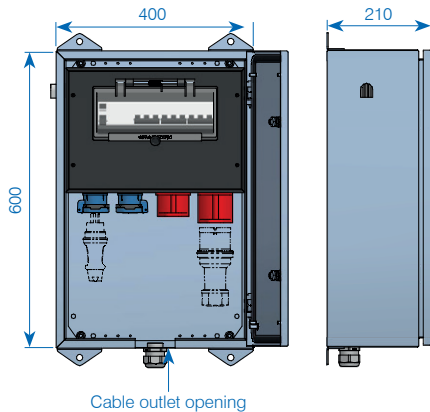

Item no.	Designation	Equipment
229879	Pre-fuse max. 63 A L×W×H = 400×600×210mm	2×T23 1×T25 1×CEE 16/5 1×CEE 32/5

Surface mounted power distribution box type 63 A

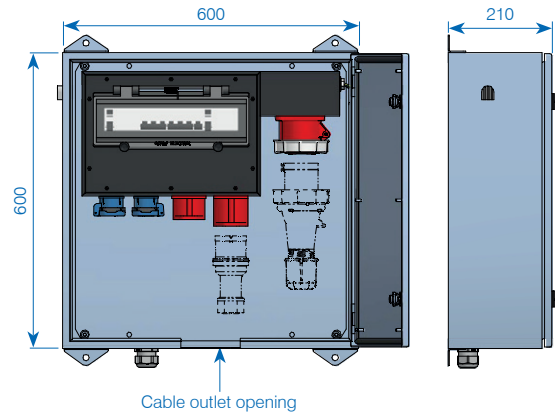

Item no.	Designation	Equipment
229891	Pre-fuse max. 63 A L×W×H = 600×600×210mm	2×T23 1×T25 1×CEE 16/5 1×CEE 32/5 1×CEE 63/5

Surface mounted power distribution box type 63 A

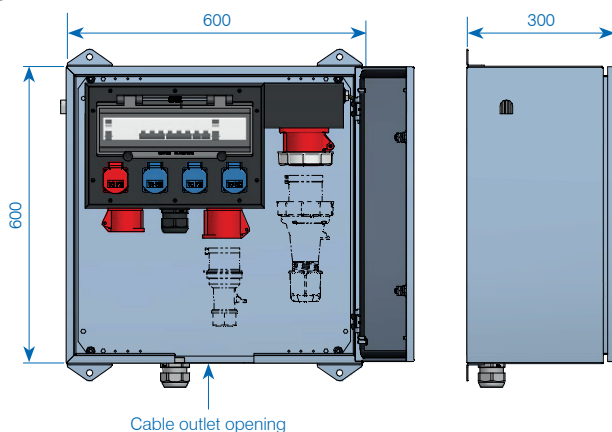

Item no.	Designation	Equipment
229903	Pre-fuse max. 63 A L×W×H = 600×600×300mm	3×T23 1×T25 1×CEE 16/5 1×CEE 32/5 1×CEE 63/5

Recessed mounted power distribution box type 32 A

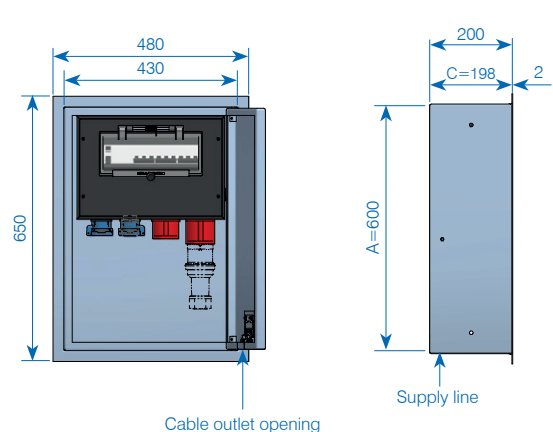

Item no.	Designation	Equipment
230093	Pre-fuse max. 63 A L×W×H = 430×600×200mm	2×T23 1×T25 1×CEE 16/5 1×CEE 32/5

Other versions, more accessories and spare parts on request.

Main distributor box 63 A
direct measurement

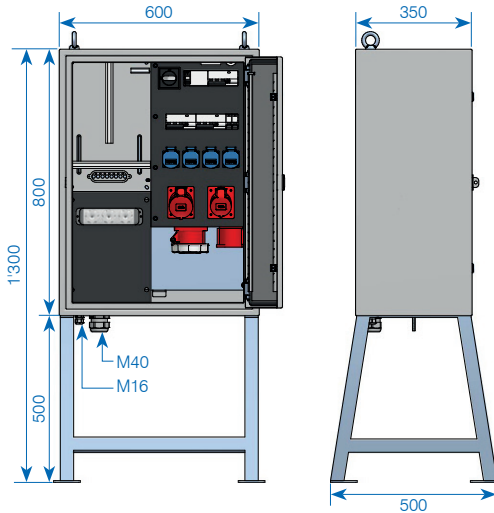

Main distributor box 100 A
direct measurement

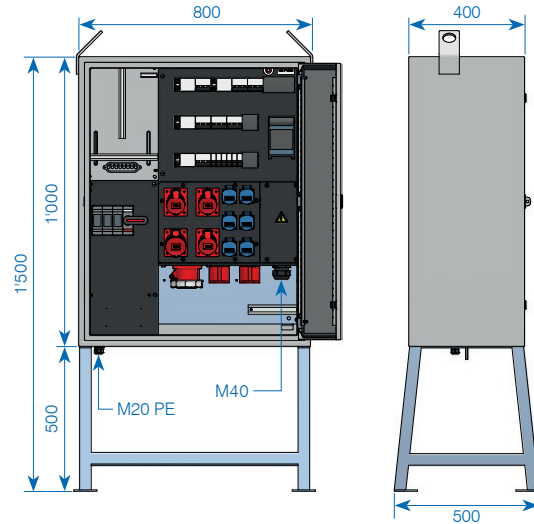

Item no.	Designation	Equipment
231123	MDB-direct measurement 63 A	4×T23 1×CEE 5×16 A 2×CEE 5×32 A / 400 V 1×CEE 5×63 A / 400 V 1×crane earth Input: 1×M40

Item no.	Designation	Equipment
✓ 231418	MDB-direct measurement 100 A	6×T23 3×CEE 5×16 A / 400 V 3×CEE 5×32 A / 400 V 1×CEE 5×63 A / 400 V 1×direct connection 63 A 1×crane earth Input: 1×M40

Electric diagram

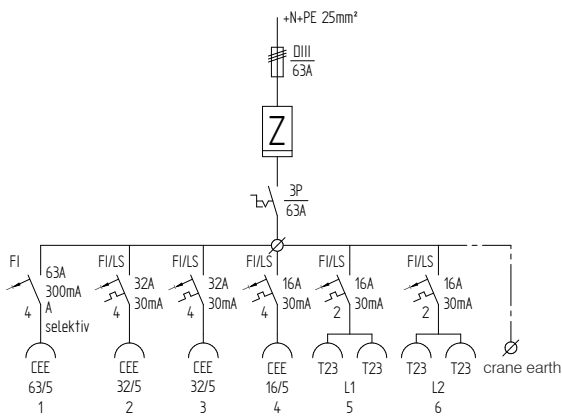

Electric diagram

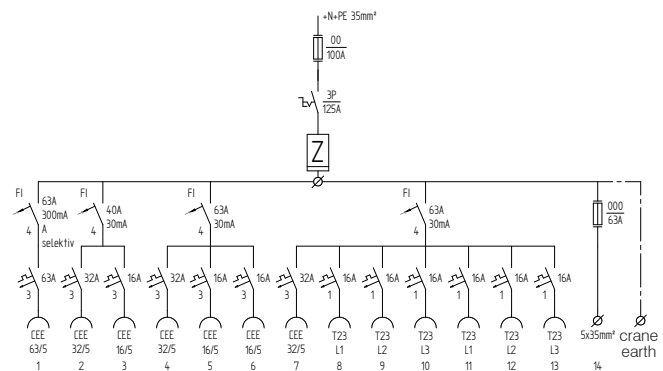

Other versions, more accessories and spare parts on request.

✓ From stock, offer subject to prior sale

Main distributor boxes (MDB) 250 A, 400 A

Main distributor box 250 A Converter measurement

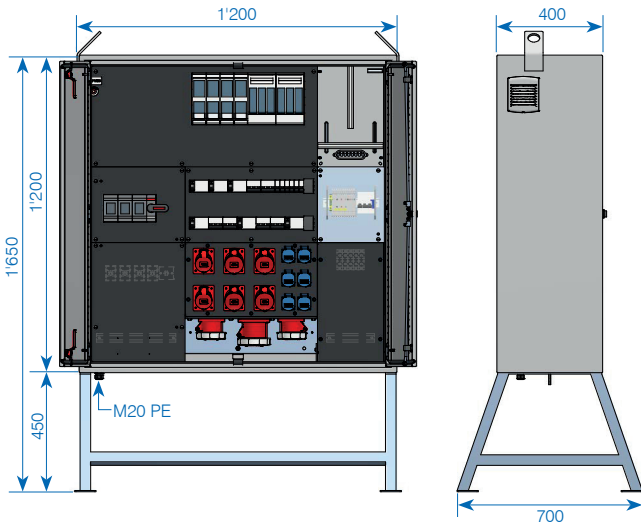

Item no.	Designation	Equipment
✓ 229292	MDB-Converter measurement 250A	6×T23 2×CEE 5×16A/400V 4×CEE 5×32A/400V 2×CEE 5×63A/400V 1×CEE 5×125A/400V 1×direct connection 160A 1×crane earth

Main distributor box 400 A Converter measurement

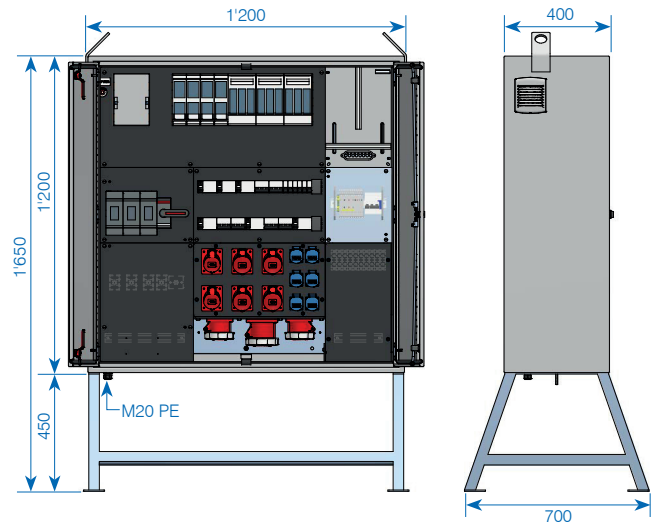

Item no.	Designation	Equipment
229296	MDB-Converter measurement 400A	6×T23 2×CEE 5×16A/400V 4×CEE 5×32A/400V 2×CEE 5×63A/400V 1×CEE 5×125A/400V 2×direct connection 160A

Electric diagram

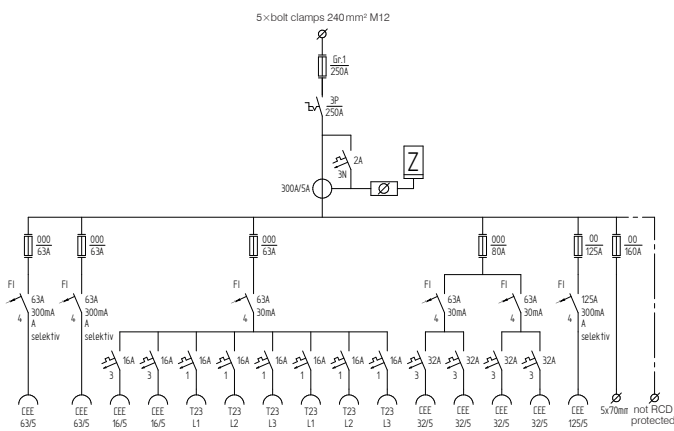

Electric diagram

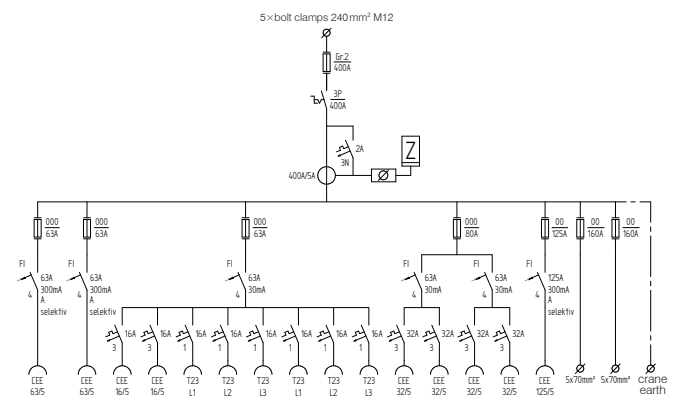

Other versions, more accessories and spare parts on request.

✓ From stock, offer subject to prior sale



ES 100 power column for gardens



Power distribution box at Oberriet railway station



Mobile power distribution box in use at a market



Cable crossover in Zurich



QUADRO power column



Cable reel with a metal body



Completely assembled and preset spring-driven cable reel

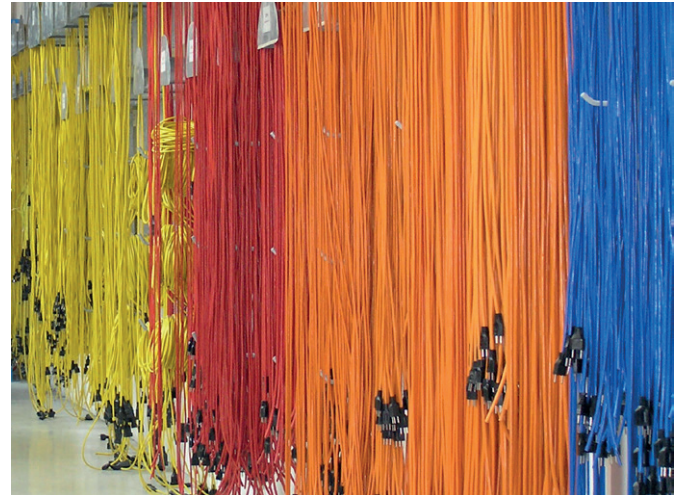

Individually prefabricated cables



Ground clamp for the welding workstation



Unobtrusive recessed distribution box



Main distributor on a construction site



Plugs and sockets used in various applications

Gifaflex: The universal, reinforced connection line Cable type CH-N07V3V3-F

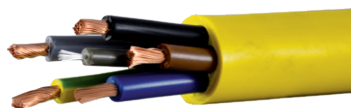

Item no.	Size No. of poles × mm ²	Strand structure mm	External-Ø	Colour
✓ 010635	2×1.0	32×0.20	7.3mm	yellow
✓ 010636	3×1.0	32×0.20	7.8mm	yellow
✓ 010642	3×1.5	30×0.25	8.6mm	yellow
✓ 010638	5×1.0	32×0.20	9.5mm	yellow
✓ 010644	5×1.5	30×0.25	10.6mm	yellow
✓ 010649	5×2.5	50×0.25	12.3mm	yellow
✓ 010653	5×4.0	56×0.30	14.9mm	yellow
✓ 010656	5×6.0	84×0.30	16.7mm	yellow

Proflex: Special cable for extremely low ambient temperature, cable type H07 RN-F

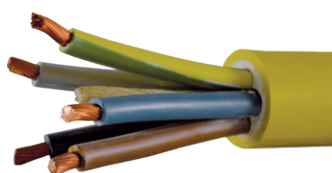

Item no.	Size No. of poles × mm ²	Strand structure mm	External-Ø	Colour
✓ 044591	5×10.0	80×0.40	24.1 mm	yellow
✓ 044595	5×16.0	128×0.40	28.4 mm	yellow

Equipment connection leads Gifaflex T23



Item no.	Plug	Size No. of poles × mm ²	Length	Colour	Protec- tion ca- te-gory
✓ 043041	T23/16A/ 250V	3×1.5	5m	yellow	IP20
✓ 043043	T23/16A/ 250V	3×1.5	10m	yellow	IP20

Please note:

Other cable colours and dimensions are available on request.
The connection cable can be printed with your company name.

✓ From stock, offer subject to prior sale

Equipment connection leads Gifaflex T11/T12/T13



IP20



IP55

Item no.	Plug	Size No. of poles × mm ²	Length	Colour	Protection category
✓ 010815	T11	2×1.0	3m	yellow	IP20
✓ 010816	T11	2×1.0	5m	yellow	IP20
✓ 010817	T11	2×1.0	10m	yellow	IP20
✓ 010840	T11	2×1.5	3m	yellow	IP20
✓ 010841	T11	2×1.5	5m	yellow	IP20
✓ 025984	T11	2×1.5	10m	yellow	IP20
✓ 010828	T12	3×1.0	3m	yellow	IP20
✓ 010829	T12	3×1.0	5m	yellow	IP20
✓ 010830	T12	3×1.0	10m	yellow	IP20
✓ 010843	T12	3×1.5	3m	yellow	IP20
✓ 010844	T12	3×1.5	5m	yellow	IP20
✓ 010845	T12	3×1.5	10m	yellow	IP20
242044	T11	2×1.0	3m	yellow	IP55
✓ 242045	T11	2×1.0	5m	yellow	IP55
✓ 242054	T11	2×1.0	10m	yellow	IP55
242047	T11	2×1.5	3m	yellow	IP55
✓ 242046	T11	2×1.5	5m	yellow	IP55
✓ 242049	T13	3×1.0	5m	yellow	IP55
✓ 242051	T13	3×1.0	10m	yellow	IP55
242052	T13	3×1.5	3m	yellow	IP55
✓ 242053	T13	3×1.5	5m	yellow	IP55
✓ 242050	T13	3×1.5	10m	yellow	IP55
✓ 242058	T13	3×1.5	25m	yellow	IP55
✓ 242055	T13	3×1.5	30m	yellow	IP55
✓ 242056	T13	3×1.5	50m	yellow	IP55

Extension cable Gifaflex



standard CH



standard CEE

Item no.	Size No. of poles × mm ²	Plug / Coupling	Version	Length
228481	3 × 1.5	T13/T13/230V	IP55/mounted	5 m
✓ 228490	3 × 1.5	T13/T13/230V	IP55/mounted	10 m
228494	3 × 1.5	T13/T13/230V	IP55/mounted	20 m
228495	3 × 1.5	T23/T23/230V	IP55/mounted	20 m
228026	5 × 1.5	T25/T25/400V	IP55/mounted	20 m
✓ 228466	5 × 1.5	T15/T15/400V	IP55/mounted	10 m
228468	5 × 1.5	T15/T15/400V	IP55/mounted	20 m
✓ 050331	5 × 2.5	CEE 16/5/400V	IP44/mounted	10 m
✓ 050332	5 × 2.5	CEE 16/5/400V	IP44/mounted	20 m
✓ 066421	5 × 6.0	CEE 32/5/400V	IP44/mounted	10 m
✓ 066521	5 × 6.0	CEE 32/5/400V	IP44/mounted	20 m
✓ 050288	5 × 16.0	CEE 63/5/400V	IP67/mounted	10 m*
✓ 050289	5 × 16.0	CEE 63/5/400V	IP67/mounted	20 m*

*Proflex

Spiral cable Pur



Item no.	Size No. of poles × mm ²	Strand structure Number × mm	Exter- nal- Ø approx. mm	Turning length mm	Use- able length mm	free ends mm
✓ 010790	3 × 1.0	32 × 0.2	7.2	800	3'200	300
✓ 010791	3 × 1.0	32 × 0.2	7.2	1'200	4'800	300
✓ 012766	5 × 1.0	32 × 0.2	9.0	800	3'200	200
✓ 010792*	3 × 1.5	30 × 0.25	8.7	800	3'200	300
✓ 010793	3 × 1.5	30 × 0.25	8.7	1'200	4'800	300
✓ 010767	4 × 1.5	30 × 0.25	9.5	800	3'200	200
✓ 015036	5 × 1.5	30 × 0.25	10.3	500	2'000	200
✓ 010795	5 × 1.5	30 × 0.25	10.3	800	3'200	200
✓ 011925	5 × 1.5	30 × 0.25	10.3	1'200	4'800	200
✓ 010796	7 × 1.5	30 × 0.25	12.5	700	2'800	200
✓ 010797	4 × 2.5	50 × 0.25	10.8	800	3'200	200

* Mantel: 05BQ-F

Extension cable with three-way coupling



Distributor boxes three-way coupling

(coupling part = small distributor box with 3 × built-in sockets)
plastic plug mounted

Plug / Coupling	Size No. of poles × mm ²	5 m	10 m	20 m
-----------------	---	-----	------	------

IP55

T13/3 × T13	3 × 1.5	✓ 228506	✓ 228521	✓ 228527
T23/3 × T23	3 × 1.5	228507	228522	228528
T15/3 × T13	5 × 1.5	✓ 228508	228523	228529
T25/3 × T23	5 × 1.5	✓ 228509	228524	228530

Please note:

The listed extensions are available in the standard colour yellow. Other cable colours and dimensions are available on request. The extensions can be printed with your company name.

✓ From stock, offer subject to prior sale

SMART

Technical data

max. load: app. 2t/400mm²
 Length: 1'000mm
 Width: 290mm
 Height: 48mm
 Channels: 3 channels
 Weight: 5kg

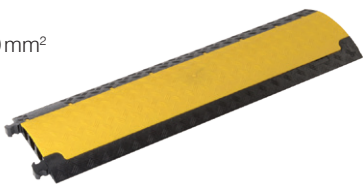

Item no.	Designation
✓ *032295	Cable crossover SMART 3 channels, 290×48×1'000mm (W×H×D)
✓ 109667	End ramp with groove
✓ 109668	End ramp with plug for SMART

MICRO

Technical data

max. load: ca. 2'000kg/400cm²
 Width: 273mm
 Height: 48mm
 Length: 1'005mm
 Channels: 2 channels
 Weight: 5.5kg



Item no.	Designation
✓ *207953	Cable crossover MICRO 2-channels 273×48×1'005mm (W×H×D)

MIDI

Technical data

max. load: app. 5t/400mm²
 Length: 890 (925) mm
 Width: 542mm
 Height: 52mm
 Channels: 5 channels
 Weight: 12kg



Item no.	Designation
✓ *016031	Cable crossover MIDI 5 channels, 542×52×890mm (W×H×D)
✓ 020840	Curve 45° for MIDI (incl. 1 pair connecting pin)
020841	End ramp for MIDI

STANDARD

Technical data

max. load: app. 5t/400mm²
 Length: 1'000mm
 Width: 600mm
 Height: 73mm
 Channels: 3 channels
 Weight: 22kg

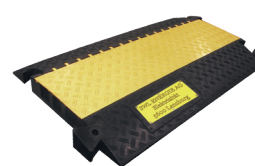

Item no.	Designation
✓ *059553	Cable crossover STANDARD, 3 channels, 600×73×1'000mm (W×H×D)
✓ 059554	End ramp for STANDARD
✓ 018359	Curve 45° for STANDARD (incl. 1 pair connecting pin)
✓ 059556	Connecting pin for STANDARD

DEFENDER 3 2D

Technical data

max. load: approx. 5'000kg/750cm²
 Dimensions (W×H×D):
 – Item no. 224766: 1'000×330×73mm
 – Item no. 242888: 500×330×73mm
 – Item no. 224767: 1'000×600×71mm
 Channels: 3 Channels
 Duct height (H×D): 2×: 52×49mm/1×: 45×50mm
 Weight:
 – Item no. 224766: 13.5kg
 – Item no. 242888: 6.75kg
 – Item no. 224767: 15.9kg



Item no.	Designation
✓ 224766	Cable crossover Defender 3 2D, 3 channels modular system, middle part, 1'000×330×73mm
✓ 242888	Cable crossover Defender 3 2D, 3 channels modular system, middle part, 500×330×73mm
✓ 224767	Ramp for cable crossover Defender 3 2D modular system, 1'000×600×71mm

COMPACT

Technical data

Length: 805mm
 Width: 435mm
 Height: 37mm
 Channels: 7 channels
 Weight: 3.6kg

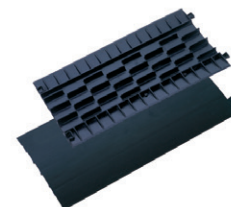

Item no.	Designation
✓ *019628	Cable crossover COMPACT, 7 channels, 435×37×805mm (W×H×D)

MAXI

Technical data

max. load: app. 5t/400mm²
 Length: 700mm
 Width: 696mm
 Height: 87mm
 Channels: 5 channels
 Weight: 21.4kg

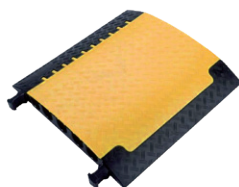

Item no.	Designation
✓ *023212	Cable crossover MAXI, 5 channels, 696×87×700mm (W×H×D)
✓ 023213	End ramp for MAXI

Hose bridge

Technical data

Length: 320mm
 Width: 830mm
 Height: 102mm
 Channels: 2 channels
 Weight: 15kg



Item no.	Designation
✓ 203954	Hose bridge solid rubber, 2 channels, 830×102×320mm (W×H×D)

* The cable bridges can be laser marked with the company name/logo from an order quantity of 30 pieces.

✓ From stock, offer subject to prior sale

Cable reel plastic type 510
L×W×H= 297×367×208 mm

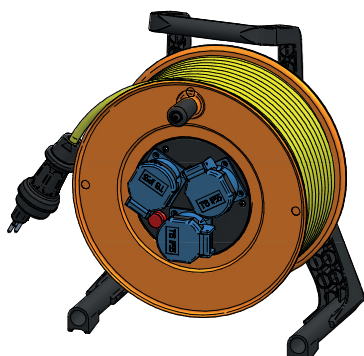

Item no.	Output	Cable length	Cable Ø	Input / plug
✓ 244628	3×T13	30m	3×1.5 mm ² Gifaflex	T13, vulcanized

with thermal protection

Cable reel plastic type 530
L×W×H= 235×320×165 mm



Item no.	Output	Cable length	Cable Ø	Input / Plug
✓ 246022	3×T13	20m	3×1.5 mm ² H07RN-F	T13, vulcanized

with thermal protection

Cable reel hard rubber type 501
L×W×H= 254×347×205 mm



Item no.	Output	Cable length	Cable Ø	Input / Plug
✓ 244924	3×T13	25m	3×1 mm ² Gifaflex	T13, vulcanized
✓ 244923	3×T13	30m	3×1 mm ² Gifaflex	T13, vulcanized

with thermal protection

Cable reel hard rubber type 502
L×W×H= 310×417×224 mm



Item no.	Output	Cable length	Cable Ø	Input / plug
✓ 244939	3×T13	35m	3×1.5 mm ² Gifaflex	T13, vulcanized
✓ 244940	3×T13	50m	3×1.5 mm ² Gifaflex	T13, vulcanized

with thermal protection

Please note:

For marking, the reel body can be engraved and/or the cable can be printed (with your company name or similar).

Other versions, more accessories and spare parts on request.

✓ From stock, offer subject to prior sale

Cable reel hard rubber type 502 L×W×H=310×417×252 mm

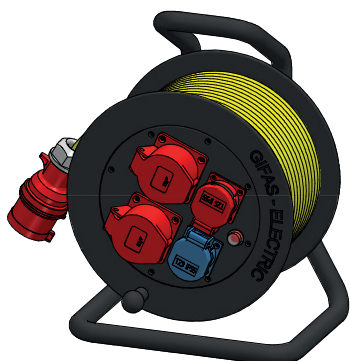

Item no.	Designation	Output	Cable	Plug
✓ 227766	hard rubber	T23, T25, 2×CEE 16/5	30 m, 5×2.5 mm ² , yellow	CEE 16/5

with thermal protection

Spring-driven cable reel type 520



Item no.	Size No. of poles×mm ²	Cable length, rolled up	Output rolled up	Output unreeled
✓ 058047	3×1.0	6 m + 1 m free	1'100 W	1'600 W
✓ 058049	3×1.5	5 m + 1 m free	1'400 W	1'900 W

with thermal protection

Cable reel hard rubber type 503/ L×W×H=340×487×300 mm

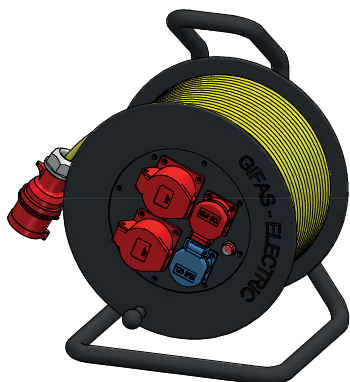

Item no.	Designation	Output	Cable	Plug
✓ 227767	hard rubber	T23, T25, 2×CEE 16/5	50 m, 5×2.5 mm ² yellow	CEE 16/5

with thermal protection

Spring-driven cable reel type 521



Item no.	Size No. of poles×mm ²	Cable length, rolled up	Output rolled up	Output un-reeled
✓ *035034	3×1.0	12.5 m + 1.5 m free	900 W	1'400 W
✓ *035063	3×1.5	10 m + 1.5 m free	1'200 W	1'800 W
✓ 035182	5×1.5	5.5 m + 1.5 m free	1'400 W	1'900 W
✓ 037942	1×6.0	12.5 m + 1.5 m free	–	–

* with thermal protection

Hose reel for air and water



Example of an engraving

Other versions, more accessories and spare parts on request.

✓ From stock, offer subject to prior sale



Item no.	Version	Hose length rolled-up	Inter- nal-Ø	Connec- tion	Pres- sure
✓ 039797	type 585	10 m + 2 m free	8 mm	1/4"	12 bar

CH-norm standard range / plugs and sockets CEE-standard

Plugs IP55



Item no.	Designation	No. of poles	Voltage (50-60Hz)	Strength of current
✓ 860813	Plug black T13	P+N+E	230V	10A
✓ 860815	Plug black T23	3P+N+E	230/400V	10A
✓ 860823	Plug black T15	P+N+E	230V	16A
✓ 860825	Plug black T25	3P+N+E	230/400V	16A

Couplings IP55



Item no.	Designation	No. of poles	Voltage (50-60Hz)	Strength of current
✓ 860814	Coupling black T13	P+N+E	230V	10A
✓ 860816	Coupling black T23	3P+N+E	230/400V	10A
✓ 860824	Coupling black T15	P+N+E	230V	16A
✓ 860826	Coupling black T25	3P+N+E	230/400V	16A

Built-in sockets IP55



Item no.	Designation	No. of poles	Voltage (50-60Hz)	Strength of current
✓ 860913	Socket blue T13	P+N+E	230V	10A
✓ 860914	Socket grey T13	P+N+E	230V	10A
✓ 860916	Socket red T15	P+N+E	230V	10A
✓ 860915	Socket black T13	3P+N+E	400V	10A
✓ 860923	Socket blue T23	P+N+E	230V	16A
✓ 860924	Socket grey T23	P+N+E	230V	16A
✓ 860925	Socket red T25	3P+N+E	400V	16A

Plugs and sockets CEE-product range plastic IP44, IP44/IP54



Item no.	Designation	No. of poles	Voltage 50-60 Hz	Strength of current
✓ 056857	Plug	2P+E	230V	16A
✓ 056864	Coupling	2P+E	230V	16A
✓ 056929	Slanted built-in socket	2P+E	230V	16A
✓ 056860	Plug	3P+N+E	400V	16A
✓ 056867	Coupling	3P+N+E	400V	16A
✓ 056931	Slanted built-in socket	3P+N+E	400V	16A
✓ 056861	Plug	3P+N+E	400V	32A
✓ 056868	Coupling	3P+N+E	400V	32A
✓ 056933	Slanted built-in socket	3P+N+E	400V	32A
✓ 021637	Wall socket*	3P+N+E	400V	16A
✓ 045997	Wall socket*	3P+N+E	400V	32A

*trough wiring, with thread M25

Plugs and sockets CEE-product range plastic IP67



Item no.	Designation	No. of poles	Voltage 50-60 Hz	Strength of current
✓ 055992	Plug	2P+E	230V	16A
✓ 056000	Coupling	2P+E	230V	16A
✓ 055975	Slanted built-in socket	2P+E	230V	16A
✓ 055993	Plug	3P+N+E	400V	16A
✓ 056001	Coupling	3P+N+E	400V	16A
✓ 055977	Slanted built-in socket	3P+N+E	400V	16A
✓ 055994	Plug	3P+N+E	400V	32A
✓ 056002	Coupling	3P+N+E	400V	32A
✓ 055980	Slanted built-in socket	3P+N+E	400V	32A
✓ 055995	Plug	3P+N+E	400V	63A
✓ 056003	Coupling	3P+N+E	400V	63A
✓ 055991	Slanted built-in socket	3P+N+E	400V	63A

Other versions, more accessories and spare parts on request.

✓ From stock, offer subject to prior sale

Special devices CEE



Item no.	Designation	No. of poles	Voltage 50-60Hz	Strength of current
✓ 056047	Test plug	3P+N+E	400V	16A
✓ 051309	Phase inverter	3P+N+E	400V	16A
✓ 051310	Phase inverter	3P+N+E	400V	32A

Personal safety switch PRCD-S IP55 RCCB adapter cable



Item no.	Designation
✓ 059069	Personal safety switch PRCD-S 10mA / 230V / 16A without cable/without coupling
✓ 222286	Personal safety switch PRCD-S 30mA / 230V / 16A without cable/without coupling
✓ 229354	RCCB adapter cable PRCD-S 2m T13/T13
229351	RCCB adapter cable PRCD-S 3m T13/3×T13, 30mA
229352	RCCB adapter cable PRCD-S 5m T13/3×T13, 10mA
229353	RCCB adapter cable PRCD-S 5m T23, 30mA

Diverse plugs and sockets



Item no.	Designation
✓ 010366	Plug T12, polyamide black, 2P+E, 10A-230V
✓ 010365	Coupling T13, polyamide black, 2P+E, 10A-230V
✓ 054924	Plug T12, polyamide white, 2P+E, 10A-230V
✓ 041991	Coupling T13, polyamide white, 2P+E, 10A-230V
✓ 010357	Distribution plug 3×T13, nylon black, 2P+E, 10A-230V
024274	Distribution plug 3×T13, nylon white, 2P+E, 10A-230V
✓ 027785	Slanted built-in T13, polyamide black, 2P+E, 10A-230V
✓ 010355	Slanted built-in 3×T13, nylon black, 2P+E, 10A-230V
✓ 044358	Plug T23, plastic, 2P+E, 16A-250V/50-60Hz
✓ 044365	Coupling T23, plastic, 2P+E, 16A-250V/50-60Hz
✓ 044374	Plug T25, plastic, 2P+N+E, 16A-250/400V/50-60Hz
✓ 044378	Coupling T25, plastic, 2P+N+E, 16A-250/400V/50-60Hz
✓ 028498	Slanted built-in 1×RJ45 Cat. 6 modul 8 yellow, IP55, incl. flat seal
✓ 026235	Slanted built-in 2×RJ45 Cat. 6 modul 8 yellow, IP55, incl. flat seal

Other versions, more accessories and spare parts on request.

✓ From stock, offer subject to prior sale

Welding cable Douflex



Item no.	Size mm ²	Exterior-Ø approx. mm
✓ 241546	16	11.0
✓ 241547	25	13.0
✓ 241548	35	15.0
✓ 241549	50	16.5
✓ 241551	70	18.0
✓ 241552	95	22.5

Set with plug and female connector or plug / ground clamp / Jumper cables for trucks or cars



Item no.	Designation	Size	Length
241675	Welding cable extension	25mm ²	10m
241676	Welding cable extension	35mm ²	10m
241677	Welding cable extension	50mm ²	10m
241678	Welding cable extension	70mm ²	10m
241717	Ground connection set	25mm ²	5m
241718	Ground connection set	35mm ²	5m
241719	Ground connection set	50mm ²	5m
241720	Ground connection set	70mm ²	5m
241674	Jumper cables orange, with 2 clamps red	50mm ²	10m
241673	Jumper cables orange, with 2 clamps black	50mm ²	10m

Ground clamp



electrolysically galvanised steel

solid brass

Ground clamp made of electrolysically galvanised steel

Item no.	Cable	Opening max.	Power max	Connection
✓ 016166	16-25mm ²	45mm	170A	Cable socket, con-tact jaw with radius
✓ 014315	16-25mm ²	45mm	170A	Cable socket, con-tact jaw with teeth
✓ 046760	50-70mm ²	60mm	400A	Cable socket
✓ 010986	25-70mm ²	70mm	600A	Cable socket

Ground clamp cast from solid brass

✓ 045431	70-95mm ²	45mm	600A	Interior connection
----------	----------------------	------	------	---------------------

Welding connections Plugs and welding coupling



Plugs

Welding coupling

Plugs

Item no.	max. power	Pin-Ø	for cable diameter
✓ 010949	200A	9.0mm	16-25mm ²
✓ 010951	400A	13.0mm	35-50mm ²
✓ 010952	600A	13.0mm	50-70mm ²
✓ *010953	600A	13.0mm	70-95mm ²

* Double screw terminal

Built-in plugs coupling with cover

Item no.	max. power	Pin-Ø	for cable diameter	Connection screw*
✓ 011029	200A	9.0mm	16-25mm ²	M8×12
✓ 010961	400A	13.0mm	35-70mm ²	M10×16
✓ 010962	600A	13.0mm	50-95mm ²	M12×20

*Connection with crimp ring terminal

Welding coupling

Item no.	max. power	Pin-Ø	for cable diameter
✓ 010965	200A	9.0mm	16-25mm ²
✓ 010966	400A	13.0mm	35-50mm ²
✓ 010967	600A	13.0mm	50-70mm ²
✓ *010968	600A	13.0mm	70-95mm ²

* Double screw terminal

Built-in welding coupling with cover

Item no.	max. power	Pin-Ø	for cable diameter	Connection screw*
✓ 011030	200A	9.0mm	16-25mm ²	M8×12
✓ 010976	400A	13.0mm	35-70mm ²	M10×16
✓ 010977	600A	13.0mm	50-95mm ²	M12×20

*Connection with crimp ring terminal

Electrode holder



Electrode holder with jaw

Electrode holder with swivel head

Electrode holder with jaw

Item no.	35%	60%	for electrode diameter Ø	for Welding cable
✓ 010980	400A	300A	2.0-5.5mm	35-50mm ²
✓ 010981	450A	300A	2.0-6.0mm	50-70mm ²

Electrode holder with swivel head

✓ 010982	400A	200A	1.0-6.0mm	35-50mm ²
✓ 010983	600A	400A	2.0-8.0mm	70-95mm ²

Other versions, more accessories and spare parts on request.

✓ From stock, offer subject to prior sale



LaneLED GFK, Glatscheras tunnel



LaneLED WALL, Torretta Bellinzona footbridge

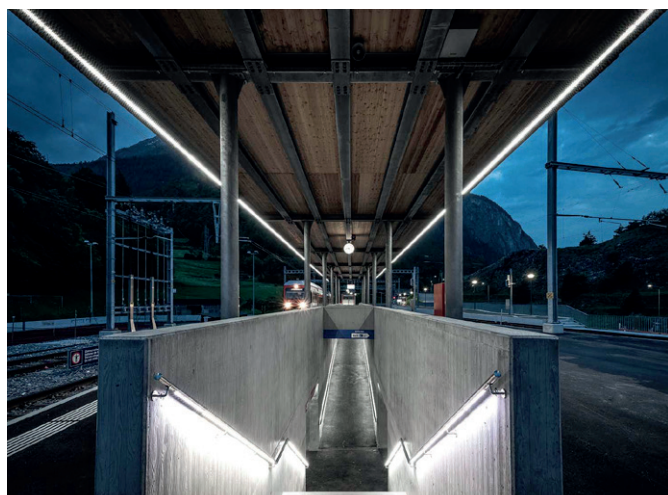

LaneLED WALL and LaneLED INOX42, railway station Sembrancher

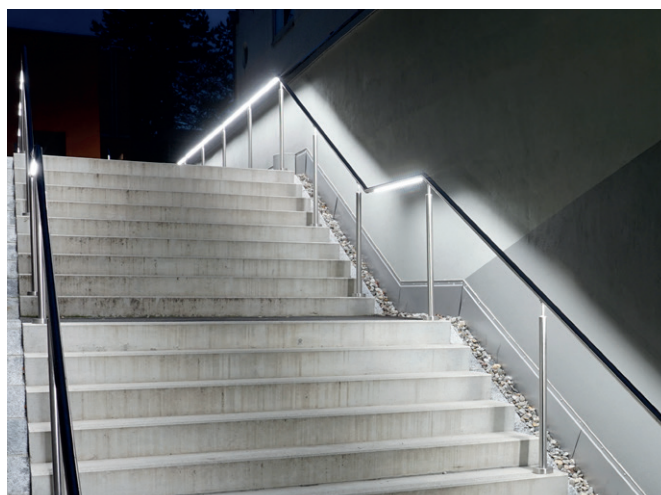

LaneLED INOX42, Lindenplatz square Baden



Portable test kit



Electric vehicle charging station, electricity station EBS Schwyz



On-site switches, type 2812 yellow, sewage treatment plant Herisau



You will find our complete range
and special solutions on

www.gifas.ch



Floor socket outlet Fonto and Masso, shopping centre Plus City



Underfloor distributor system, St. Jakob-Park stadium in Basel



CircLED roundabout Bachenbülach



VisuLED HOME, Jura Elektroapparate AG Niederbuchsiten

GET IN TOUCH WITH US

News about the assortment and specific solutions can be found on our website:

www.gifas.ch

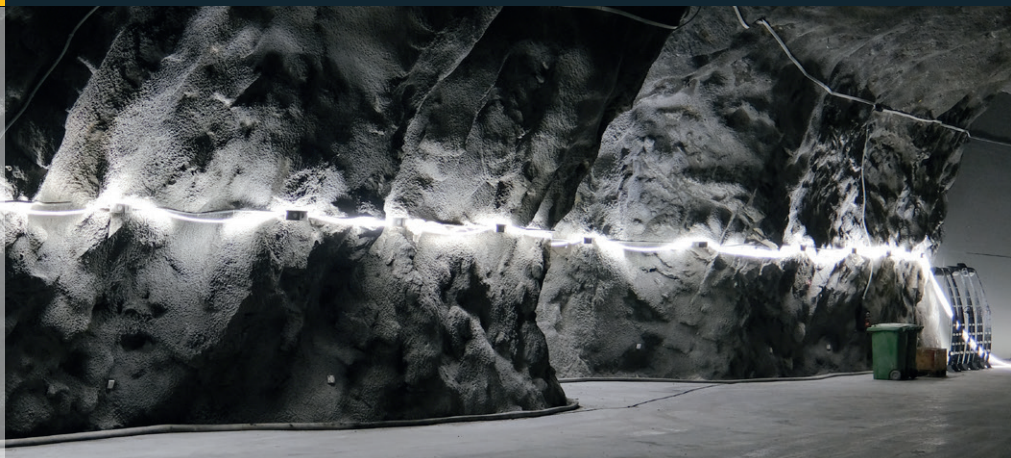

We reserve the right to make technical modifications. V 01/24

GIFAS
ELECTRIC

GIFAS-ELECTRIC GmbH
Dietrichstrasse 2
CH-9424 Rheineck

+41 71 886 44 44
+41 71 886 44 49
info@gifas.ch
www.gifas.ch